

ADVANTAGE

ULTRAVIOLET STERILIZER

INSTALLATION MANUAL

**2,000 and 2,000+
Hanger Model**

**2,000 and 2,000+
Barb x Barb Model**



AQUA
ULTRAVIOLET

EPA Est 68177-CA-001

MAILING ADDRESS

PO Box 2189
Temecula, CA 92593

MAIN OFFICE

42371 Avenida Alvarado
Temecula, CA 92590
Toll Free: (800) 454-2725
Tel: (951) 296-3480
www.aquauv.com



Find us on Facebook
www.facebook.com/aquauv



Follow us on Instagram
www.instagram.com/aquauv



See us on YouTube
www.youtube.com/AquaUltraviolet



TABLE OF CONTENTS

1	Important Information
2-3	Warranty
4	Introduction
4	How Ultraviolet Works
4	Sizing Chart
5	Frequently Asked Questions
6	Pond/Aquarium Layouts
7	Hanger Installation Instructions
8	Barb X Barb Installation Instructions
9	Trouble Shooting Leaks
10	Installing The Lamp
11	Changing Lamps
12	Cleaning or Changing Quartz Sleeves
13	Winterizing
14	Incorrect Installation
15	Replacement Parts

THANK YOU FOR PURCHASING THE BEST ULTRAVIOLET SYSTEM

IMPORTANT INFORMATION



WE CAN HELP YOU

Returning this product is expensive and time consuming for you, your retailer and for us, the manufacturer. Should you encounter any problems with your product, please call our toll free "HELP" line for assistance
(800) 454-2725 or email info@aquauv.com.

PLEASE DO NOT return your product to the store! Your dealer or distributor cannot offer any warranty work on your product.



**In the US please call
TOLL FREE (800) 454-2725
(951) 296-3480 Outside the U.S.
THANK YOU!**

WARRANTY INFORMATION

Aqua Ultraviolet systems are warranted against failure due to defects in materials and/or workmanship during the warranty period. This warranty covers defects occurring under normal use and applies to the original retail purchaser and may not be transferred. The warranty and remedies set forth herein are conditional upon proper storage, installation, use, maintenance and conformance with the applicable use. It will be based upon Aqua Ultraviolet's discretion as to whether the defects are of manufacturing origin.

This warranty does not apply to appearance or accessory items. This warranty does not include damage due to shipping and handling, transportation, unpacking, set up, installation, improper maintenance, incorrect line voltage, modification, abuse, misuse, neglect, accident, fire, flood, acts of God or repair or replacement of parts supplied by anyone other than Aqua Ultraviolet.

Any oral statements about this product made by the seller, the manufacturer, their representatives or any other party does not constitute warranties and shall not be relied upon by the user and are not part of this contract.

Neither the seller nor the manufacturer shall be liable for any injury, loss or damages, direct, incidental or consequential including but not limited to lost profits, lost sales, injury, inability to use the product and the user agrees that no other remedy is available.

Before installing, the user shall determine the suitability of the product for their intended use and the user shall assume all risk liability whatsoever in connection therewith.

To validate this warranty, mail the enclosed warranty card within 10 days of purchase or register online at www.aquauv.com/support/productregistration

To have warranty work done the original receipt must be provided.

Warranty Period:

Housing: Limited lifetime warranty on housing against Ultraviolet degradation.

Complete Unit: One year from the date of purchase or 18 months from manufacturing date.

Limitations:

Warranty does not cover any malfunction from improper installation (we recommend that a licensed electrician install your system to the specifications outlined in this owners guide).

Warranty only applies to the original end user and is not transferable.

Warranty does not cover repairs done by anyone other than Aqua Ultraviolet.

Warranty is void if system is not plugged into a G.F.C.I. (Ground Fault Circuit Interrupter).

Warranty may not be modified by verbal statements by Aqua Ultraviolet, distributors, retailers, their agents or any other party.

Warranty covers the repair or prorated replacement of the Aqua Ultraviolet products.

Aqua Ultraviolet denies all liability for any other loss including but not limited to loss of equipment, income, livestock, pets, aquatic life or personal injuries.

There are no warranties on the Quartz Sleeve.

There are no warranties on broken Lamps. Lamps are prorated by usage.

WARRANTY CONTINUED

Warranty is voided by the following:

Product labels defaced or removed.

Housing has been painted.

Product is improperly installed or maintained by user or agent.

Product abused, misused or damaged by user or their agent.

Product damage caused by electrical surges, electrical spikes, electrical brown outs or improper voltage.

Electrical cord has been cut.

Unit was run without water.

Use of anything other than genuine Aqua Ultraviolet Parts.

Damage from water to electrical components.

Any implied warranty granted under state law including warranties of merchantability or fitness for a particular purpose are limited to one year from the date of purchase or 18 months from the date of manufacture or as otherwise stated in the above warranty. Aqua Ultraviolet is not responsible for direct, indirect, incidental or consequential damages. Some states do not allow limitations on how long an implied warranty lasts and/or does not allow the exclusions or limitations of incidental damages so the above limitation and exclusion may not apply to you. This warranty gives you special legal rights and you may also have other rights that vary from state to state.

Warranty Returns or Repair Returns:

Please call Aqua Ultraviolet at (800) 454-2725 for a "Return Merchandise Authorization" (RMA) number, or e-mail info@aquauv.com. You must have a valid RMA from an Aqua Ultraviolet customer service representative before sending any product in for warranty or repair. Please have your serial number, date of purchase and product type available when calling for an RMA number.

All warranty returns or repair returns must come freight prepaid with an RMA number clearly marked on the outside of the box. All other returns will be refused. Aqua Ultraviolet will not be liable for any shipping cost to return warranty or repair items. Include a note in the box with your RMA number, name, address, daytime phone number and brief description of the reason for return or repair.

Be sure to return product in the same packing or similar packing and insure the package (we recommend sending it UPS). If you do not have or can not locate proper packaging, please call our customer service department and we will send you packaging for a minimal charge.

Aqua Ultraviolet shall not be responsible for damage or loss done by the shipper. Nor shall Aqua Ultraviolet be responsible for merchandise that arrives damaged due to improper packaging. All claims for loss and damage must be filed by the customer with the shipper.

If the unit is found to be out of warranty we will contact you with the cost of repair. Your authorization is required prior to making any repairs.

We at Aqua Ultraviolet would like to take the time to thank you for purchasing the finest ultraviolet system on the market.

For over thirty years, Aqua Ultraviolet has manufactured ultraviolet systems that are in use in various industries, including aquaculture, public and commercial aquariums, educational institutions, government agencies and research organizations throughout the world.

Aqua Ultraviolet sterilizers are used as a control to destroy single celled organisms, water borne bacteria, viruses, algae, fungi and protozoa. Aqua Ultraviolet sterilizers are recommended for both fresh and salt water systems as well as ponds. There are no residual effects when using an Aqua Ultraviolet sterilizer. Ultraviolet will not affect Bio-filters or lower fish immune systems!

HOW ULTRAVIOLET WORKS

The ultraviolet lamp emits a germicidal ray which alters or disrupts the DNA or RNA of single celled organisms such as algae, bacteria and protozoa. By properly implementing an Aqua Ultraviolet System in-line, these organisms can be eradicated effectively without any harmful residuals.

Your Aqua Ultraviolet System was made to work as a control for green water and single celled organisms. This unit will not, nor will any other unit, completely sterilize your pond/aquarium as the pond/aquarium itself is not a sterile environment. As a control, this unit will effectively lower your water bacterial count allowing your fish to stay healthier with less risk of disease.

Aqua Ultraviolet Sterilizers work best on filtered water. Any debris in the water can inhibit UV transmission.



CAUTION: READ ALL INSTRUCTIONS CAREFULLY BEFORE BEGINNING INSTALLATION OR OPERATION.



NOTE: THE QUARTZ SLEEVE MAY NEED PERIODIC CHECKING AND CLEANING DUE TO CALCIUM AND MINERAL BUILD UP WHICH WILL DIMINISH UV TRANSMISSION.

The following instructions should answer most of the questions that you may have about the installation, operation and use of your new Aqua Ultraviolet Sterilizer. View our installation videos at www.aquauv.com. If you need technical support, we offer this service for free by telephone (800) 454-2725 or (951) 296-3480, or email info@aquauv.com. Our phones will be answered M-F 8:00 am - 3:30 pm Pacific Standard Time except selected holidays. You may reach us through the web at www.aquauv.com.

SIZING CHART

Advantage Series Units	No. Of Lamps	120V Amp Draw	Fresh Water Pond Clarifier		Size Fresh Water Pond Sterilizer* in Gallons	30,000	45,000	60,000	75,000	90,000	**Salt
			Max Flow Gallons	GPH		$\mu\text{w}/\text{cm}^2$ (EOL) GPH	$\mu\text{w}/\text{cm}^2$ (EOL) GPH	$\mu\text{w}/\text{cm}^2$ (EOL) GPH	$\mu\text{w}/\text{cm}^2$ (EOL) GPH	Water Tank Gallons	
Advantage 2000	1	0.42	1,500	1,000	5 - 200	642	428	321	256	214	70
Advantage 2000+	1	0.42	2,000	1,800	200 - 500	700	466	350	280	233	75

To achieve the optimum kill rates the UV must be run continuously. Constant "On and Offs" may shorten the life of the lamp and transformer.

*As a sterilizer (for crystal clear water) UV dosage is 30,000 $\mu\text{w}/\text{cm}^2$ (EOL) at max flow rate.

**Salt water gallons are based on higher UV kill rate (targeting free floating parasites, i.e., Ich).

***As a clarifier, water clarity is dependent on amount of sun, local temperatures, plant coverage, shallowness of pond, etc.

FREQUENTLY ASKED QUESTIONS

Where do I install my UV?

The best place to install your Aqua Ultraviolet system is after the filter. If an after the filter installation is not feasible, your sterilizer can be installed before the filter, but it will take a little longer to work. If installed before the filter, be aware that a small rock passing from the pump can break the quartz sleeve. It is recommended that if you install your unit before your filter, you check the UV periodically for any water leakage due to a broken quartz sleeve. Be sure to have adequate pre-filtration to prevent breakage. (A broken quartz sleeve and any damage caused by a broken quartz sleeve is not covered under warranty.)

Do I have to turn my UV off when I clean my filter?

Yes, but only if the chamber is drained or if the water will remain at a stand still for more than 30 minutes. Note: Running longer than the recommended time without water flow can cause extensive damage to the unit that is not covered under warranty.

What should I expect after my UV is installed?

If your Aqua Ultraviolet system is installed after the filter and is properly sized the water should be clear in 3-5 days. If your Aqua Ultraviolet system is installed before the filter the water should be clear in 7-10 days. The green algae on the sides and bottom of the pond will not disappear, this is normal in a pond. The UV does not control this type of algae.

What's the difference between a sterilizer and a clarifier?

As a sterilizer, your Aqua UV system will keep your pond or aquarium water crystal clear, plus you will have the added benefit of bacterial control which will help keep your fish healthy and happy with less risk of disease. As a clarifier the algae will be reduced, your pond water will still have a green tint to it, unless you have 50-75% plant coverage or your pond is in full shade.

Do I install my UV vertically or horizontally?

You can install it either way - (see installation Instructions Page 8). The hanger model only installs vertically.

What should my flow rate be on my pond or fresh water aquarium?

The optimum flow rate on your pond or fresh water aquarium is to turn over the volume of water one time every hour to every hour and a half.

What should my flow rate be on my salt water aquarium?

Your flow rate should be 3 to 5 times the volume of water per hour.

Should any of the water bypass the UV?

No. Our UV was specifically designed to handle high flow rates for easier installation and the best water quality.

Is this unit submersible? No, not this specific series.

Does the UV light have any residual effect to the fish?

UV only affects what passes through the chamber. There is no residual effect from UV light.

Does the UV kill good bacteria?

Ultraviolet light does not discriminate about what it destroys. If good bacteria passes by the light it will be destroyed. Beneficial bacteria are colonized in your filter and along the sides and bottom of your pond. The only time those will be affected is if it becomes free floating and passes through the UV.

How often should I change my lamp?

The lamp should be changed after 14 months of continuous use. Use only Genuine Aqua Ultraviolet Lamps or the warranty is voided.

RECOMMENDED POND LAYOUT

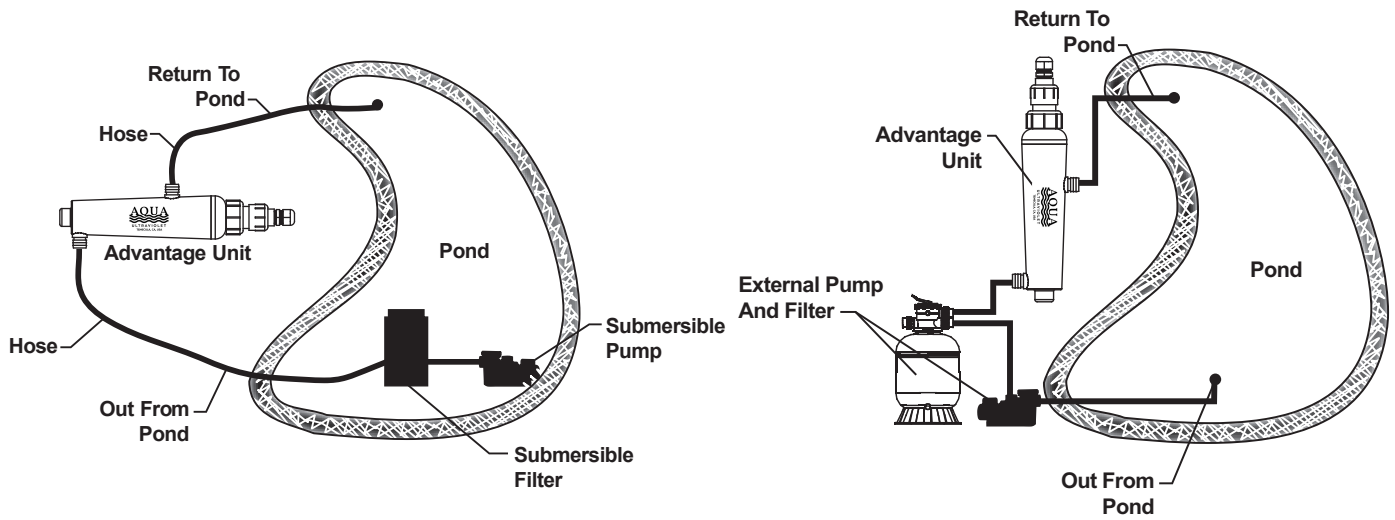

RECOMMENDED AQUARIUM LAYOUT

HANGER UNIT

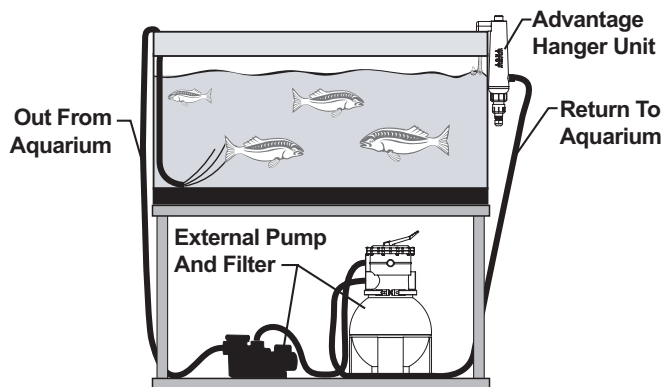

BARB X BARB

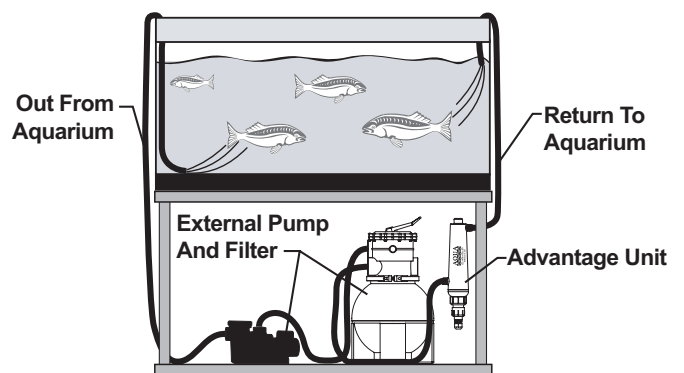

ADVANTAGE HANGER INSTALLATION

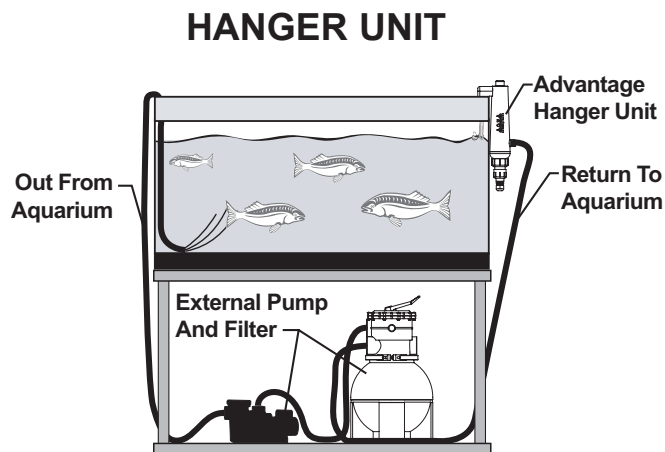

1. Connect to your existing pump with a flexible hose and secure with hose clamps (hose clamps are not included, purchase separately along with your hose).
2. Hang the Advantage Unit on the aquarium with the hanger spout directed down inside of the aquarium.
3. Before you connect the Lamp and Transformer a leak test must be conducted.

LEAK TEST: Do not install Lamp or electrical components yet. After all the hose connections have been made, turn the pump on and run it for five minutes to check for leaks.

- a. If you have a leak, follow steps for trouble shooting leaks on page 9. Carefully examine this unit after installation. This unit should not be plugged in if there are any leaks on any part of this unit.
- b. If there are no leaks, continue with the Lamp and electrical installation on page 10.

ADVANTAGE BARB X BARB INSTALLATION

BARB X BARB

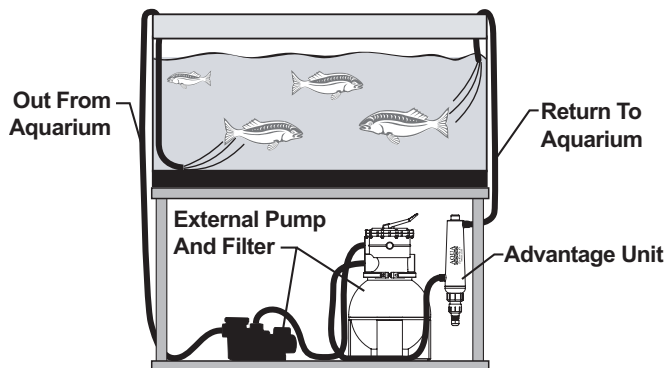

Pond with submersible pump and filter

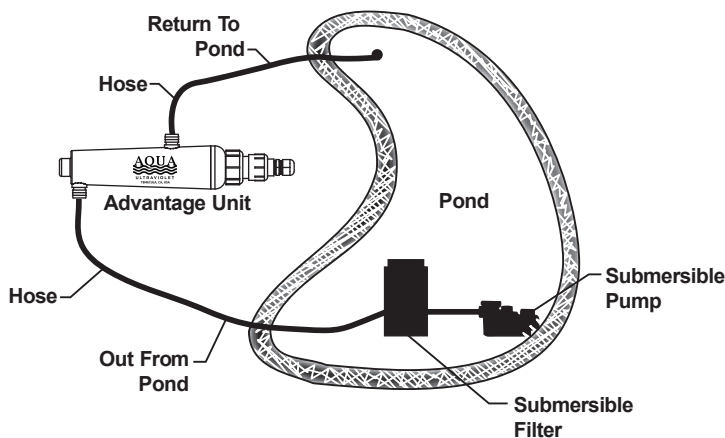

Pond with external pump and filter

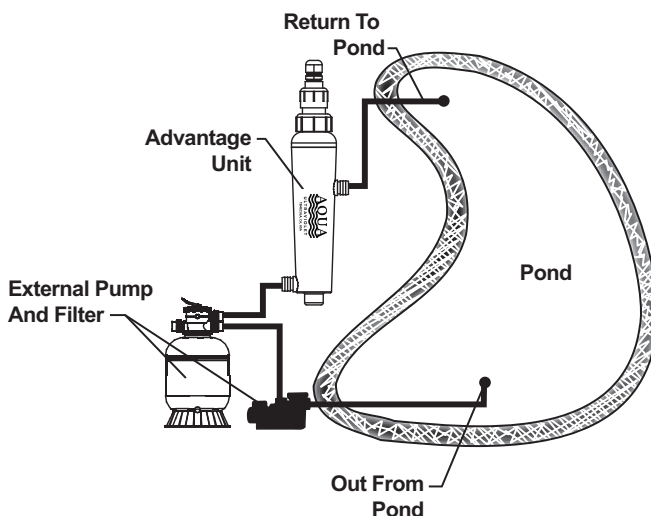

1. Connect to your existing pump with a flexible hose and secure with hose clamps (hose clamps are not included, purchase separately along with your hose).
2. Connect a hose to opposite barb and secure with hose clamps. Hose should return water to the opposite end of your aquarium or pond.
3. Before you connect the Lamp and Transformer a leak test must be conducted.

LEAK TEST: Do not install Lamp or electrical components yet. After all the hose connections have been made, turn the pump on and run it for five minutes to check for leaks.

- a. If you have a leak, follow steps for trouble shooting leaks on page 9. Carefully examine this unit after installation. This unit should not be plugged in if there are any leaks on any part of this unit.
- b. If there are no leaks, continue with electrical installation on page 10.

TROUBLE SHOOTING LEAKS

Leaks from Quartz Cap / Rubber Seal

1. Undo Quartz Cap and push Rubber Seal in to the Advantage body evenly. Half the Rubber Seal will still be in view. Screw on the Quartz Cap and hand tighten. Do not use a pipe wrench, pliers or any other tool. Hand-tighten only.

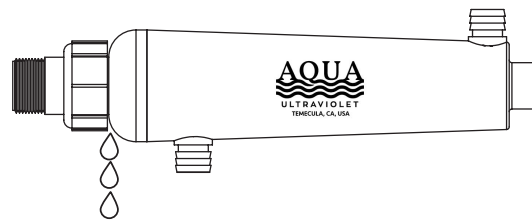

Leaks from Center of Quartz Cap

2. The Quartz Sleeve is broken and needs to be replaced. Neither the broken Quartz Sleeve nor any damage caused as a result of a broken Quartz Sleeve is covered under warranty. Contact your dealer for a replacement. Use genuine Aqua Ultraviolet parts or the warranty is voided.
(See Changing the Quartz Sleeve on page 12).

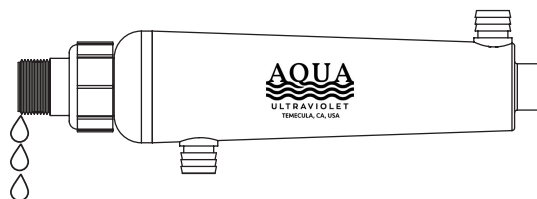

INSTALLING THE LAMP



NOTE: If you touch the Lamp use denatured alcohol and a soft cloth to clean the Lamp. If you do not clean the Lamp the fingerprints will become etched into the glass which will diminish UV output and may cause premature lamp failure.



NOTE: Lamps and Quartz Sleeves should be handled with care. Lamps and Quartz Sleeves are not warranted against breakage and damage.



WARNING: Do not install the Lamp at an angle (even a slight angle); this may cause a U shaped crack at the end of the Quartz Sleeve, or possible breakage of the Lamp. If this should happen, do not proceed with the installation. Purchase a new Quartz Sleeve or Lamp from your dealer and refer to the proper installation instructions.



NOTE: Do not force the Lamp into the Quartz Sleeve.

1. Unscrew the Davis Connector located behind the Transformer Cap, this allows your Transformer Cap to spin freely.

2. Before inserting the Lamp into the unit plug the Lamp flush into the Lamp End Connector. If the Lamp is not plugged in all the way it may cause damage to the unit and is not covered under warranty.

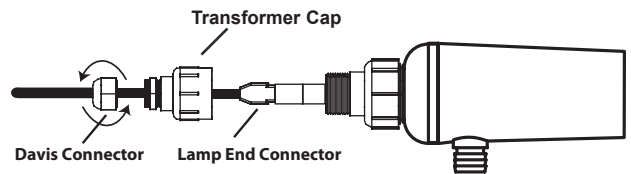

3. Insert the Lamp straight into the Quartz Sleeve. Be careful, inserting the Lamp at an angle, even a slight angle, can cause a "U" shaped crack in the Quartz Sleeve.

4. Screw on the Transformer Cap. Do not over tighten. This is a connection only and is not in contact with water.

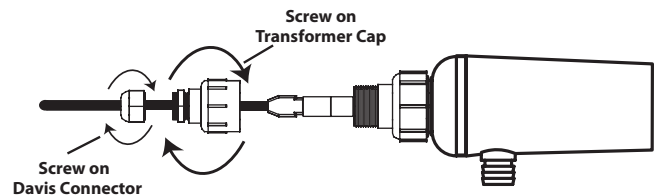

5. Tighten the Davis Connector located behind the Transformer Cap.

6. **FINAL LEAK CHECK:** Do not plug the Sterilizer into power yet, turn on the pump, let water run for 5 minutes and check for leaks.

7. Once a leak test is completed, and there are no leaks, plug the Transformer into a GFCI outlet.



CAUTION: Do not look at or handle UV Lamps when lit outside of the housing. Considerable Ultraviolet energy is emitted which may produce severe sunburn and/or conjunctivitis. As long as the UV light is in its housing it is 100% safe for humans and fish.



NOTE: The average life expectancy of Aqua Ultraviolet Lamps is 14 months of continuous operation. After 14 months the lamp may still light, but the UV has diminished.



NOTE: We recommend that the UV sterilizer be used in continuous operation for 24 hours a day, 7 days a week. Frequent starts and stops may shorten the life of your Lamps.



WARNING: If you are medicating your fish, we recommend shutting down the sterilizer as the UV Radiation may affect the treatment.



CAUTION: Do not use the Aqua Ultraviolet Sterilizer for anything other than its intended use.



CAUTION: Always turn off the pump and disconnect electricity from the unit prior to any maintenance.

Changing the Lamp

** We recommend changing the purple seal on the quartz sleeve when you change your lamp & after winterizing.*

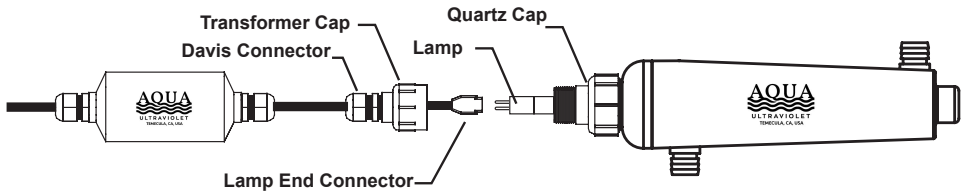

1. Unplug the UV from the power source and turn off the pump.

2. Unscrew the Davis Connector located behind the Transformer Cap, this allows your Transformer Cap to spin freely.

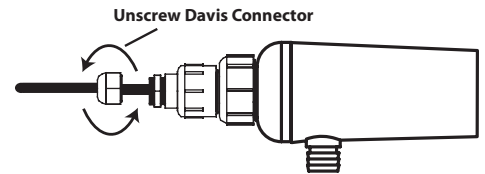

3. Unscrew the Transformer Cap.

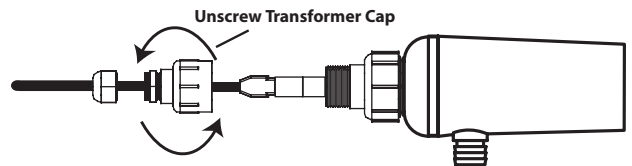

4. Slide Lamp out, be careful not to slide the Lamp out at an angle, even a slight angle, this may cause a "U" shaped crack at the end of the Quartz Sleeve, or possible breakage of the Lamp.

5. Disconnect the Lamp End Connector from the old Lamp. Replace the Lamp with Genuine Aqua Ultraviolet Lamps or the warranty is voided.

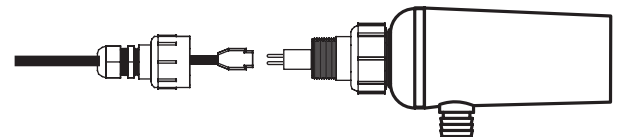

6. Plug the new Lamp flush into the Lamp End Connector. If the Lamp is not plugged in all the way it may cause damage to the unit and is not covered under warranty.

7. Insert the Lamp straight into the Quartz Sleeve. Be careful, inserting the Lamp at an angle, even a slight angle, can cause a "U" shaped crack in the Quartz Sleeve.

8. Screw on the Transformer Cap. Do not over tighten, hand tighten only. This is a connection only and is not in contact with water.

9. Tighten the Davis Connector located behind the Transformer Cap.

10. FINAL LEAK CHECK: Do not plug the Sterilizer into power yet, turn on the pump, let water run for 5 minutes and check for leaks.

11. Once a leak test is completed and there are no leaks, plug the Transformer into a GFCI outlet.

CLEANING OR CHANGING THE QUARTZ SLEEVE

1. Unplug the UV from the power source and turn off the pump.

2. Unscrew the Davis Connector located behind the Transformer Cap, this allows your Transformer Cap to spin freely.

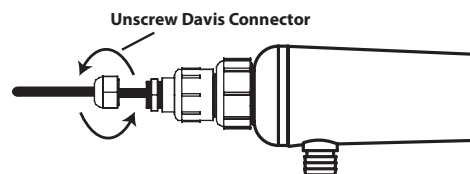

3. Unscrew the Transformer Cap.

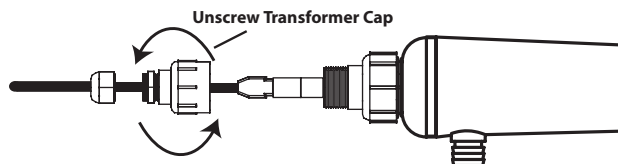

4. Slide Lamp out, be careful not to slide the Lamp out at an angle, even a slight angle, this may cause a "U" shaped crack at the end of the Quartz Sleeve, or possible breakage of the Lamp.

5. Remove the Quartz Cap.



NOTE: The Lamps and Quartz Sleeves should be handled with care. Lamps and Quartz Sleeves are not warranted against breakage and damage.

6. Using a soft cloth, grasp the Quartz Sleeve and turn and pull the Quartz Sleeve along with its Rubber Seal.

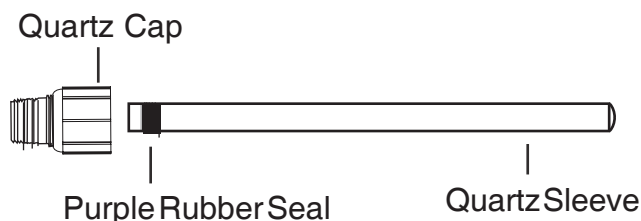

7. Once the Quartz Sleeve is removed, it can be cleaned with Lime Away, CLR or similar products.

8. We recommend replacing the Rubber Seal at 14 months when changing the Lamp.

9. To reinstall the Quartz Sleeve, carefully insert the Quartz Sleeve into the end of the Advantage Unit. Use Only Genuine Aqua Ultraviolet Quartz Sleeves or the warranty is voided.

10. Push the Rubber Seal into the UV Body. The Rubber Seal should be 1/4" from the end of the Quartz Sleeve, 1/2 of the Rubber Seal should be visible.

11. Screw on the Quartz Cap. Do not use a pipe wrench, pliers or any other tool on this unit. Tighten by hand only.

CLEANING OR CHANGING THE QUARTZ SLEEVE

12. **Run Leak Test** . Do not install Lamp or electrical components yet. After the Quartz Sleeve has been installed, turn on pump and run it for five minutes to check for leaks. If there are leaks see page 9 for solutions.
13. When there are no leaks install the lamp. Refer to page 11.



CAUTION: GFCI Information: The warranty is null and void if the unit is not plugged into a G.F.C.I. (Ground Fault Circuit Interrupter). A Surge Suppressor should be added for extra protection, it is not required, but recommended.



CAUTION: Improper connection of the equipment to a grounding conductor can result in the risk of electrocution. Check with a qualified electrician or service person if there is any doubt the outlet is being properly grounded. Do not modify the plug provided with the unit; if the plug does not fit the outlet have a proper outlet installed by an electrician.



CAUTION: Do not lay the transformer or unit on the ground. Prevent the transformer from lying in standing water. Never bury any part of the UV.



CAUTION: Do not operate unit if it has a damaged cord or plug, if it is malfunctioning, or if has been dropped or damaged in any manner.



CAUTION: If the unit falls into the water, **DO NOT** reach for it. First unplug the unit and then retrieve it. If the electrical components of the unit get wet unplug the unit immediately.



CAUTION: If an extension cord is necessary, a cord with a proper rating should be used, a cord rated for fewer amperes or watts than the unit rating may overheat. Care should be taken to arrange the cord so that it will not be tripped over or pulled.

Winterizing

If you are using your Advantage Unit outdoors in climates where freezing is possible, the unit must be removed and stored for winter. The lamp should be removed from the unit and stored separately to avoid breakage.

INCORRECT INSTALLATION

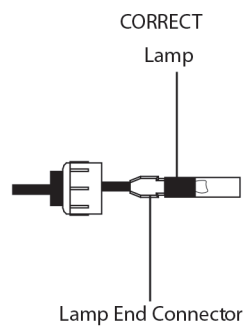
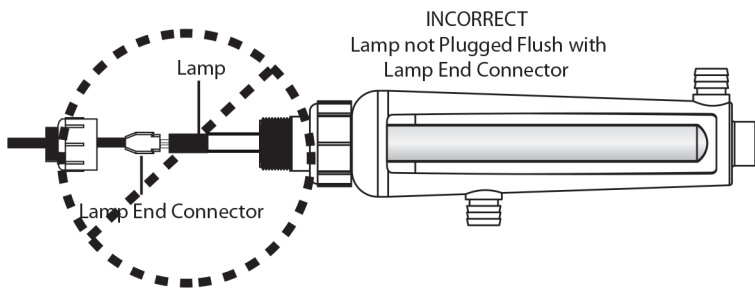
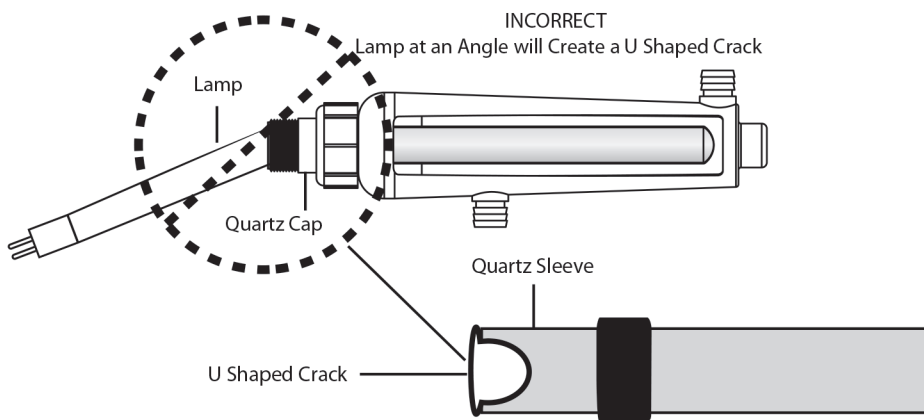
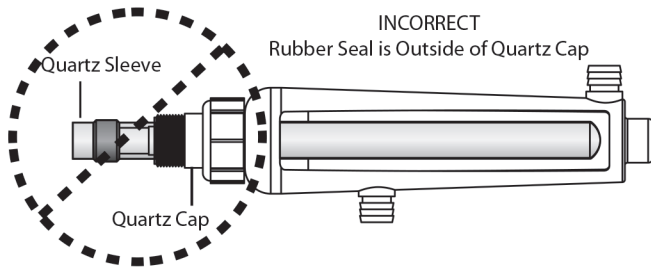



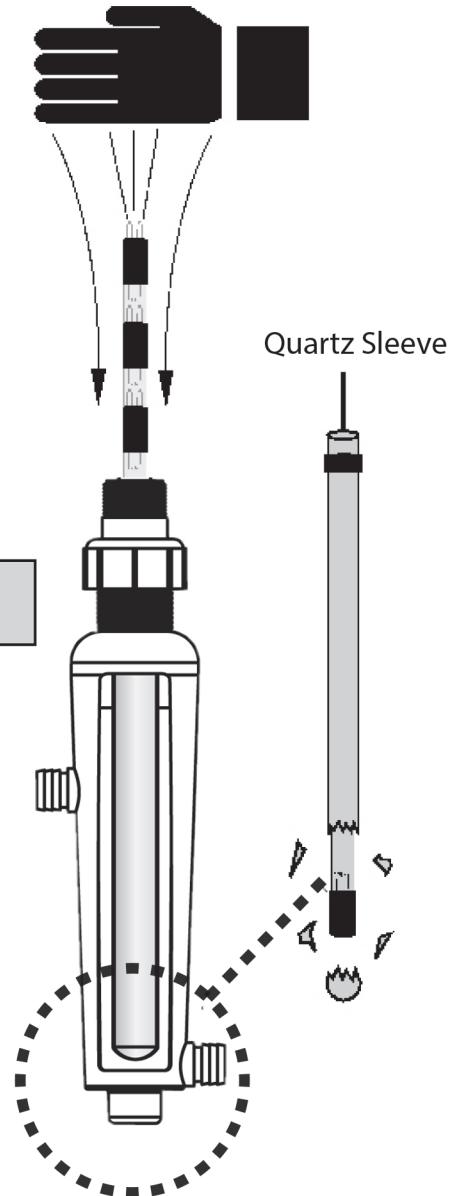



Lamp Dropped in Quartz Sleeve
Can Cause Breakage

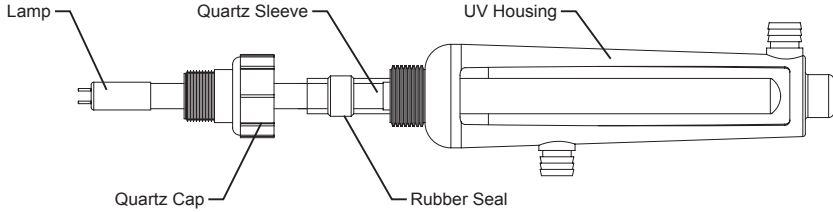
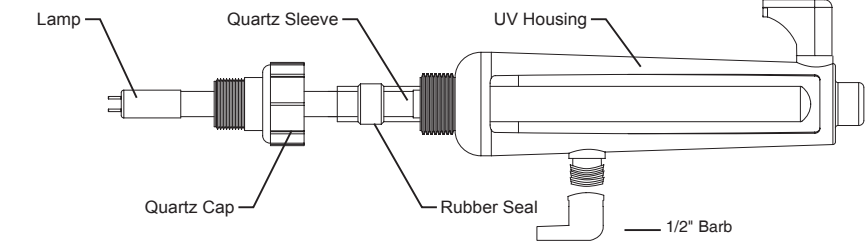
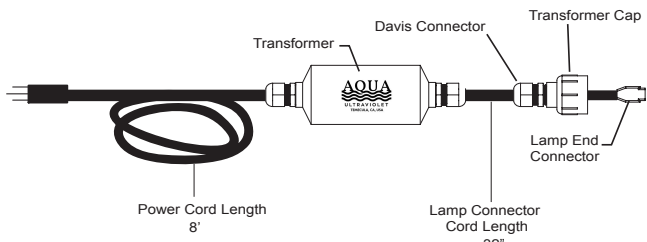

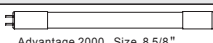
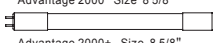
REPLACEMENT PARTS

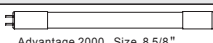
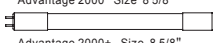
Use Only Genuine Aqua Ultraviolet parts or the warranty is voided.

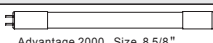
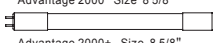
THE ADVANTAGE UNITS																									
<p>BARB X BARB</p>  <p>Lamp, Quartz Sleeve, UV Housing, Quartz Cap, Rubber Seal</p> <p>HANGER</p>  <p>Lamp, Quartz Sleeve, UV Housing, Quartz Cap, Rubber Seal, 1/2" Barb</p>	<p style="text-align: center;">PARTS</p> <table border="1" style="width: 100%; border-collapse: collapse;"> <tr><td>A10003</td><td>Advantage 2000 Quartz Sleeve (8 Watt)</td></tr> <tr><td>A10004</td><td>Advantage 2000+ Quartz Sleeve (15 Watt)</td></tr> <tr><td>A20006</td><td>Advantage 2000 Lamp (8 Watt)</td></tr> <tr><td>A20010</td><td>Advantage 2000+ Lamp (15 Watt)</td></tr> <tr><td>A30013</td><td>Advantage 2000 Transformer (8 Watt)</td></tr> <tr><td>A30017</td><td>Advantage 2000+ Transformer (15 Watt)</td></tr> <tr><td>A40246</td><td>Barb, 1/2" (for Hanger model)</td></tr> <tr><td>A40109</td><td>Davis Connector</td></tr> <tr><td>A40002</td><td>Lamp End Connector</td></tr> <tr><td>A40011</td><td>Clear Quartz Cap</td></tr> <tr><td>A40004</td><td>Rubber Seal</td></tr> <tr><td>A40113</td><td>Black Transformer Cap</td></tr> </table>	A10003	Advantage 2000 Quartz Sleeve (8 Watt)	A10004	Advantage 2000+ Quartz Sleeve (15 Watt)	A20006	Advantage 2000 Lamp (8 Watt)	A20010	Advantage 2000+ Lamp (15 Watt)	A30013	Advantage 2000 Transformer (8 Watt)	A30017	Advantage 2000+ Transformer (15 Watt)	A40246	Barb, 1/2" (for Hanger model)	A40109	Davis Connector	A40002	Lamp End Connector	A40011	Clear Quartz Cap	A40004	Rubber Seal	A40113	Black Transformer Cap
A10003	Advantage 2000 Quartz Sleeve (8 Watt)																								
A10004	Advantage 2000+ Quartz Sleeve (15 Watt)																								
A20006	Advantage 2000 Lamp (8 Watt)																								
A20010	Advantage 2000+ Lamp (15 Watt)																								
A30013	Advantage 2000 Transformer (8 Watt)																								
A30017	Advantage 2000+ Transformer (15 Watt)																								
A40246	Barb, 1/2" (for Hanger model)																								
A40109	Davis Connector																								
A40002	Lamp End Connector																								
A40011	Clear Quartz Cap																								
A40004	Rubber Seal																								
A40113	Black Transformer Cap																								
<p style="text-align: center;">THE ADVANTAGE SERIES TRANSFORMER UV</p>  <p>Transformer, Davis Connector, Transformer Cap, Lamp End Connector, Power Cord Length 8', Lamp Connector Cord Length 32'</p>	<table border="1" style="width: 100%; border-collapse: collapse;"> <thead> <tr style="background-color: #cccccc;"> <th colspan="2" style="text-align: center;">Quartz Sleeve</th> <th style="text-align: right;">Part Number</th> </tr> </thead> <tbody> <tr> <td></td> <td>Advantage 2000 Size 11 1/2"</td> <td style="text-align: right;">A10003</td> </tr> <tr> <td></td> <td>Advantage 2000+ Size 11 1/2"</td> <td style="text-align: right;">A10004</td> </tr> <tr> <td colspan="3" style="background-color: #cccccc; text-align: center;">UV Lamps</td> </tr> <tr> <td colspan="2"></td> <td style="text-align: right;">Part Number</td> </tr> <tr> <td></td> <td>Advantage 2000 Size 8 5/8"</td> <td style="text-align: right;">A20006</td> </tr> <tr> <td></td> <td>Advantage 2000+ Size 8 5/8"</td> <td style="text-align: right;">A20010</td> </tr> </tbody> </table>	Quartz Sleeve		Part Number		Advantage 2000 Size 11 1/2"	A10003		Advantage 2000+ Size 11 1/2"	A10004	UV Lamps					Part Number		Advantage 2000 Size 8 5/8"	A20006		Advantage 2000+ Size 8 5/8"	A20010			
Quartz Sleeve		Part Number																							
	Advantage 2000 Size 11 1/2"	A10003																							
	Advantage 2000+ Size 11 1/2"	A10004																							
UV Lamps																									
		Part Number																							
	Advantage 2000 Size 8 5/8"	A20006																							
	Advantage 2000+ Size 8 5/8"	A20010																							

WARRANTY RETURNS OR REPAIRS

Warranty Returns or Repair Returns:

Please call Aqua Ultraviolet at (800) 454-2725 for a "Return Merchandise Authorization" (RMA) number or email info@aquauv.com. You must have a valid RMA from an Aqua Ultraviolet customer service representative before sending any product in for warranty or repair. Please have your serial number, date of purchase and product type available when calling for an RMA number.

All warranty returns or repair returns must come freight prepaid with an RMA number clearly marked on outside of the box. All other returns will be refused. Aqua Ultraviolet will not be liable for any shipping cost to return warranty or repair items. Include a note in the box with your RMA number, name, address, daytime phone number and brief description of the reason for return or repair.

Be sure to return product in the same packing or similar packing and insure the package (we recommend sending it UPS). If you do not have or can not locate proper packaging, please call our customer service department and we will send you packaging for a minimal charge.

Aqua Ultraviolet shall not be responsible for damage or loss done by the shipper. Nor shall Aqua Ultraviolet be responsible for merchandise that arrives damaged due to improper packaging. All claims for loss and damage must be filed by the customer with the shipper.

If unit is found to be out of warranty we will contact you with the cost of repair. Your authorization is required prior to making any repairs.



EPA Est 68177-CA-001

MAILING ADDRESS

PO Box 2189
Temecula, CA 92593

MAIN OFFICE

42371 Avenida Alvarado
Temecula, CA 92590
Toll Free: (800) 454-2725
Tel: (951) 296-3480
www.aquauv.com